

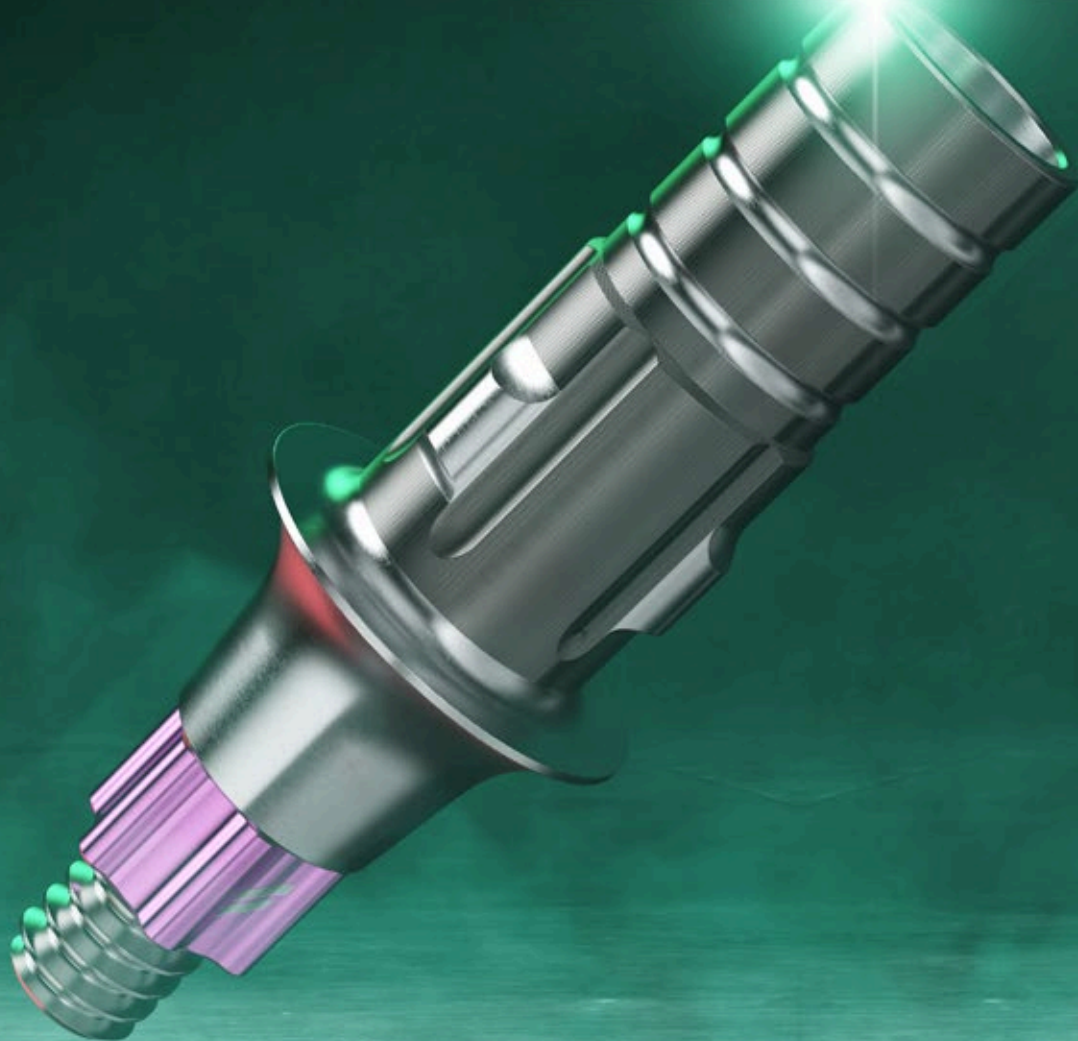

STRAUMANN® VARIOBASE® XC

Efficiency and flexibility in one.



STRAUMANN® VARIOBASE® XC EFFICIENCY AND FLEXIBILITY IN ONE

Discover the confidence that comes with a system trusted by over 95,000 dental professionals worldwide.¹ The Straumann® Variobase® XC portfolio for the Straumann iEXCEL™ Performance System empowers both dental technicians and restorative dentists to deliver a tailored solution for each unique case with unrivaled flexibility and precision.

 *"I want to create flawlessly executed work where every detail reflects my craftsmanship."*

Straumann® Variobase® XC gives you control over every detail. Multiple gingiva heights and consistent emergence profiles help shape natural soft-tissue contours, while a 7 mm flex chimney and angulated screw channel options provide the freedom to achieve uncompromised esthetics.



RELIABILITY

Deliver fit, structural integrity and retention you can rely on with Straumann® Variobase® XC and its original Straumann implant-abutment connection.² The next generation builds on the clinically proven performance of its predecessor, with enhanced abutment-crown bonding strength designed to reduce the risk of debonding.³



EFFICIENCY

Straumann® Variobase® XC helps you achieve uncompromised esthetics with ease from start to finish. Streamline ordering with the Straumann® TorcFit™ connection and customization with the versatile 7 mm high chimney. Skip sandblasting at the end thanks to the retention of the patent-protected laser surface.³



FLEXIBILITY

Whether for screw-retained or cement-retained, digital or conventional workflows, the comprehensive and streamlined Straumann® Variobase® XC portfolio enables you to offer customized restorations with ease, even in challenging cases.⁴



“The new and improved Straumann® Variobase® XC is a fantastic addition to the Straumann prosthetic portfolio. Before, I might have had to opt for a custom-made solution, but with the new Straumann® Variobase® XC we have even more possibilities for different restorations.”

Dr. Mona Eide, Norway

STRAUMANN® VARIOBASE® XC

THE NEXT GENERATION OF VARIOBASE®

1 INTEGRATED CUTTING GROOVES

Customize the 7 mm high chimney quickly and precisely.

2 PATENT-PROTECTED LASER-TREATED SURFACE

Enhances cement retention for improved bonding.³

3 ANTI-ROTATION NOTCHES

Prevents rotation and increases surface contact for extra stability.

4 RANGE OF GINGIVA HEIGHTS

Multiple options available to meet your patients' needs.

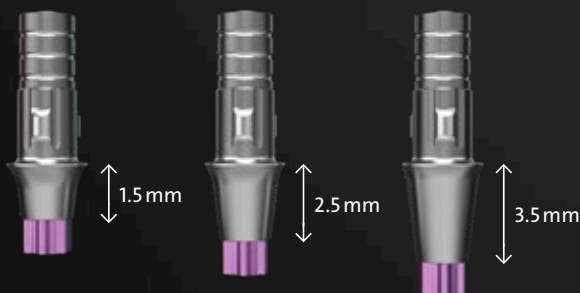



ANGULATION FLEXIBILITY

Supports up to 25° angulation, expanding treatment possibilities.

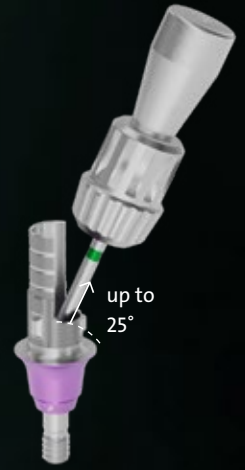

VERSATILE APPLICATIONS

Suitable for both single- and multi-unit restorations.

SEAMLESS DIGITAL INTEGRATION

Compatible with your preferred digital workflow systems.



CONSISTENT EMERGENCE PROFILES™

Optimize the soft tissue management process with the uniform emergence profile of the Straumann iEXCEL™ bone-level abutments.

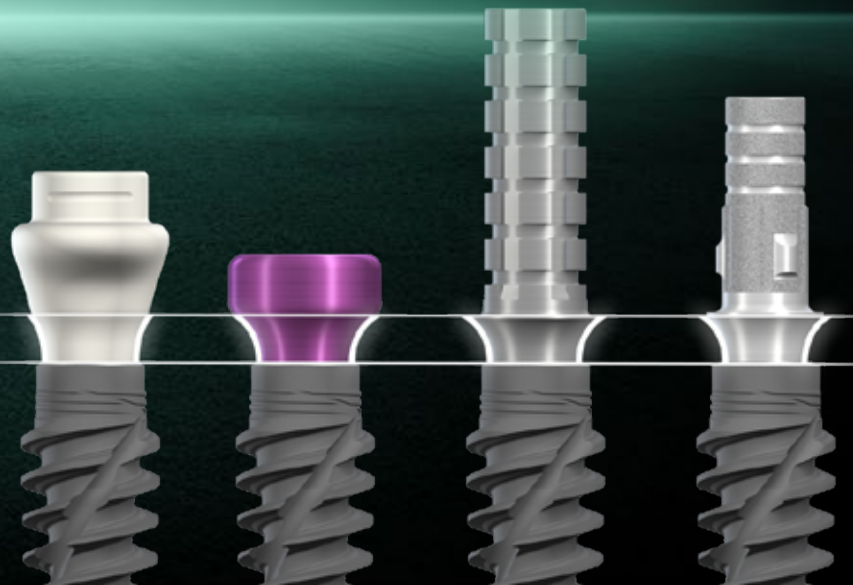

ENHANCED BONDING FOR A SURE FIT

MACHINED SURFACE

Straumann® Variobase®



LASER-TREATED SURFACE*

Straumann® Variobase® XC

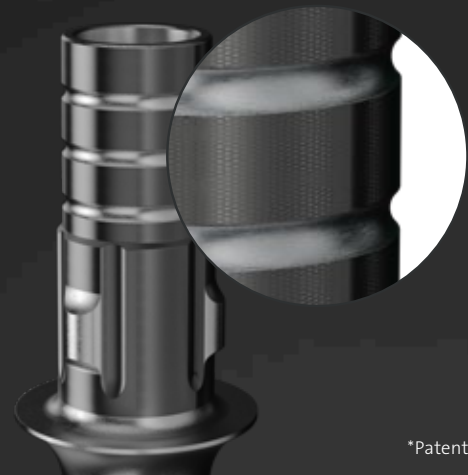

*Patent-protected

ALL THE BENEFITS OF SANDBLASTING. WITHOUT THE RISK.

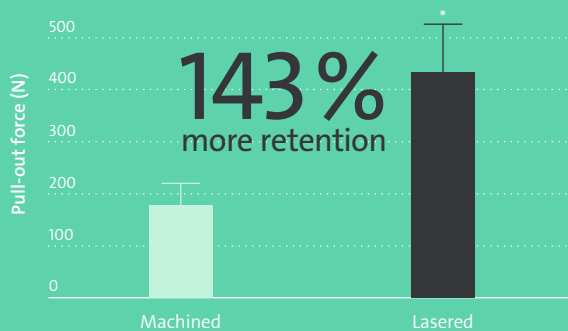

We roughen the abutment surface with a proprietary laser treatment, eliminating the step of sandblasting³ and helping you to avoid the known risks of the process:^{5,6}

- Altering tolerances or structural components
- Reducing structural strength
- Potential contamination

NOTE: The shortest length (3.5 mm) was used for this laboratory study.

Enjoy the peace of mind that comes with Straumann® Variobase® XC, knowing Straumann's Swiss engineering and precision manufacturing is completely intact.

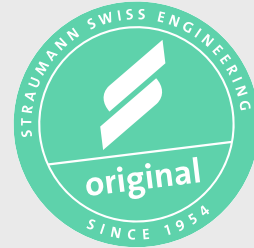

THE FOUNDATION OF GENUINE QUALITY

STRAUMANN®

ORIGINAL

The confidence that comes with peace of mind:

- Design harmony between implant and abutment with very high manufacturing precision
- Excellent fatigue test performance
- Long-term clinical evidence
- Guaranteed long-term availability of prosthetic components
- Exceptional service and support including the Straumann Guarantee

COMPATIBLE IS NOT ORIGINAL. WHICH ONE DO YOU TRUST?

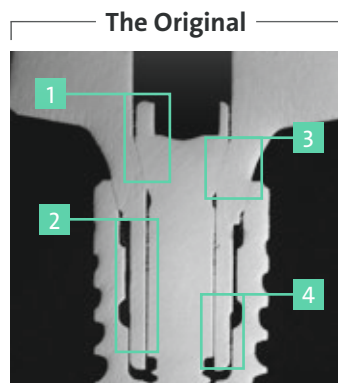

Straumann® CARES® Ti Abutment on Straumann® RC 4.1 Implant

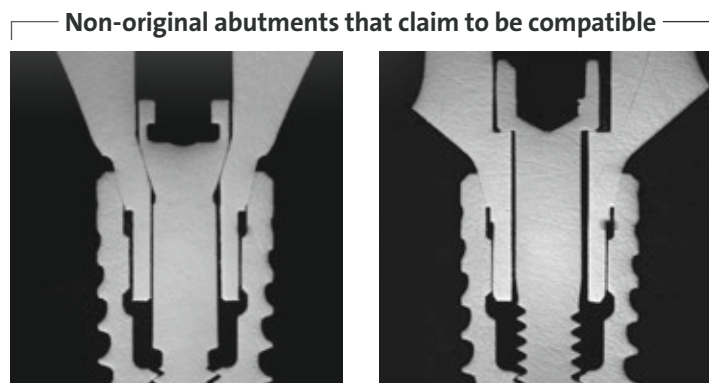

NobelProcera™ CAD/CAM Ti abutment on Straumann® RC 4.1 Implant

Atlantis™ CAD/CAM Ti abutment on Straumann® RC 4.1 Implant

LIFETIME GUARANTEE ON STRAUMANN® VARIOBASE® XC ABUTMENTS

- We are so confident in the performance and reliability of Straumann® Variobase® XC that we offer the Straumann Lifetime Guarantee
- For more details, refer to www.straumann.com/guarantee



STRAUMANN® VARIOBASE® XC DIGITAL WORKFLOW

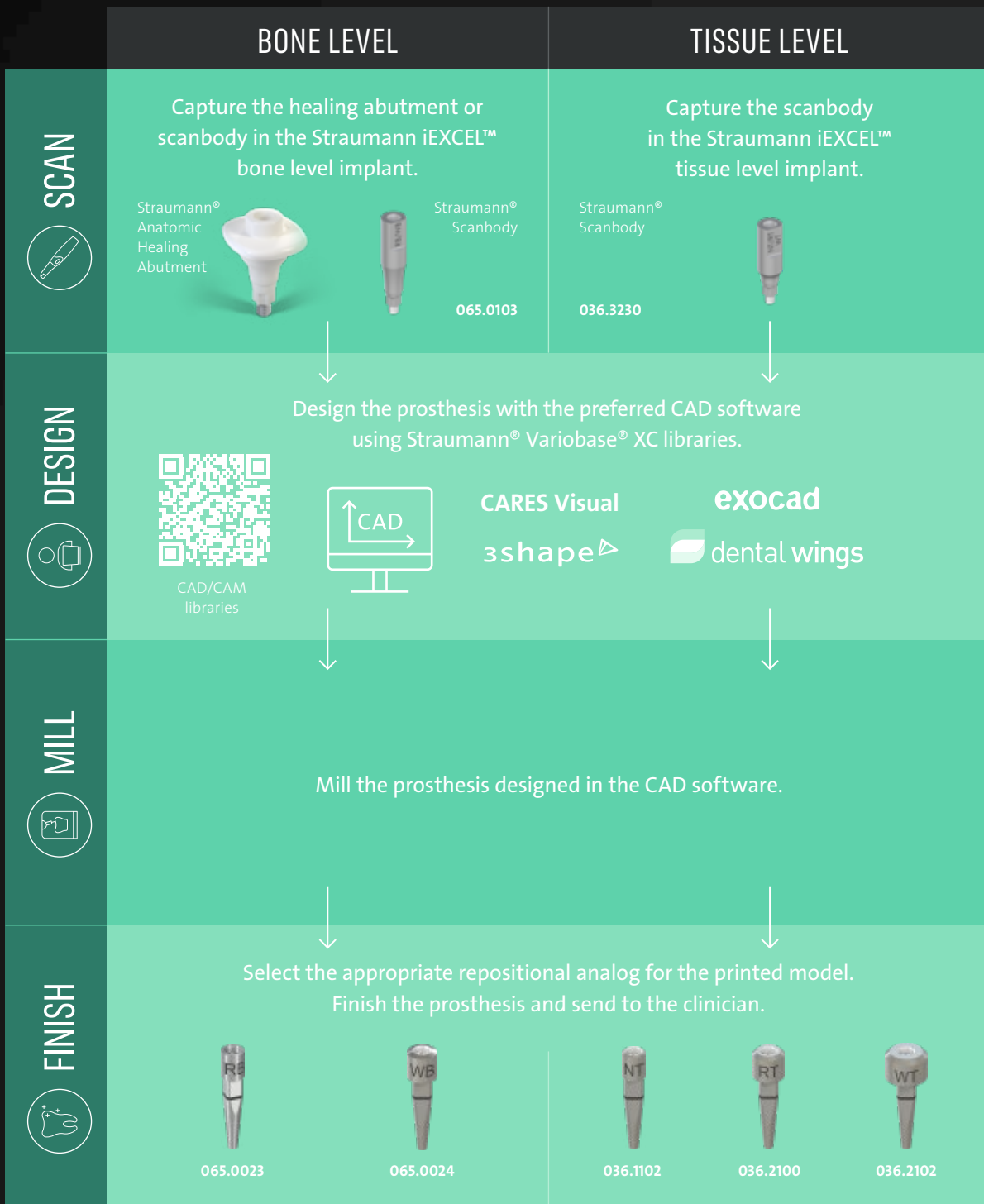

NOTE: Centralized and conventional workflows are also available.



STRAUMANN® VARIOBASE® XC PORTFOLIO FOR SINGLE-UNIT RESTORATIONS



		FOR CROWN		FOR CROWN AS	
					
		Gingiva height (mm)	Article number	Gingiva height (mm)	Article number
Straumann iEXCEL™ BL (BLX/BLC)	RB/WB Ø 3.8	1.5	062.5017	Not available	
		2.5	062.5018		
		3.5	062.5019		
	RB/WB Ø 4.5	1.5	062.5020	1.5	062.5009
		2.5	062.5021	2.5	062.5010
		3.5	062.5022	3.5	062.5011
	WB Ø 5.5	0.75	062.5023	0.75	062.5012
		1.5	062.5024	1.5	062.5013
		2.5	062.5059	2.5	062.5060
		WB Ø 6.5	1.5	062.5061	1.5
	2.5		062.5062	2.5	062.5064
	Straumann iEXCEL™ TL (TLX/TLC)	NT		062.5025	
RT			062.5026		062.5015
WT			062.5027		062.5016

STRAUMANN® VARIOBASE® XC PORTFOLIO MULTI-UNIT RESTORATIONS IMPLANT-LEVEL

		FOR BARS/BRIDGES		FOR BARS/BRIDGES AS	
					
		Gingiva height (mm)	Article number	Gingiva height (mm)	Article number
Straumann iEXCEL™ BL (BLX/BLC)	RB/WB Ø 3.8	1.5	062.5065	Not available	
		2.5	062.5066		
		3.5	062.5067		
	RB/WB Ø 4.5	1.5	062.5068	1.5	062.5073
		2.5	062.5069	2.5	062.5074
		3.5	062.5070	3.5	062.5075
	WB Ø 5.5	0.75	062.5071	0.75	062.5076
		1.5	062.5072	1.5	062.5077
	Straumann iEXCEL™ TL (TLX/TLC)	NT		062.5003	
RT			062.5004		062.4993
WT			062.5005		062.4994

STRAUMANN® VARIOBASE® XC PORTFOLIO MULTI-UNIT RESTORATIONS

ABUTMENT-LEVEL

FOR CROWN		FOR BARS/BRIDGES		FOR BARS/BRIDGES AS	
					
SRA Diameter (mm)	Article number	SRA Diameter (mm)	Article number	SRA Diameter (mm)	Article number
4.6	023.0038	4.6	023.0040	4.6	023.0041

BL*

*Straumann iEXCEL™ BL (BLX/BLC)

STRAUMANN® VARIOBASE® XC – EFFICIENCY AND FLEXIBILITY IN ONE.

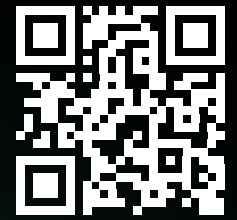

Discover
Straumann® Variobase® XC

- Designed for freedom, engineered for confidence
- Trusted by experienced dental professionals,
perfected for today's challenges

REFERENCES

1 Customer sales data from 2024. **2** Wittneben JG, Buser D, Salvi GE, Bürgin W. Complication and failure rates with implant-supported fixed dental prostheses and single crowns: a 10-year retrospective study. Clin Implant Dent Relat Res. 2014 Jun;16(3):356–64. **3** Straumann, data on file. **4** Derksen W, Wismeijer D, Flügge T, Hassan B, Tahmaseb A. The accuracy of computer-guided implant surgery with tooth-supported, digitally designed drill guides based on CBCT and intraoral scanning: a prospective cohort study. Clin Oral Implants Res. 2019;30:1005–1015. **5** Prabowo H, Laksono H, Ariani MD, Raihansyah OF. Mechanical changes of sandblasted Ti-6Al-4V using 100 µm Al₂O₃ after dynamic pressure treatment: an in vitro study. World J Adv Res Rev. 2022;16(3):583-588. **6** Altac AA & Alkhalidi EF. The effect of sandblast and plasma surface treatment of titanium abutment on tensile bond strength with ultra-translucent zirconia crown: a comparative study. Erbil Dent J. 2024. 7(2):144-151



491.048/en/B/00 03/26

International Headquarters

Institut Straumann AG
Peter Merian-Weg 12
CH-4002 Basel, Switzerland
Phone +41 (0)61 965 11 11
Fax +41 (0)61 965 11 01
www.straumann.com

© Institut Straumann AG, 2026. All rights reserved.
Straumann® and/or other trademarks and logos from Straumann® mentioned herein are the trademarks or registered trademarks of Straumann Holding AG and/or its affiliates.

iEXCEL*
STRAUMANN® PERFORMANCE SYSTEM

 **straumann**